

# Rapid, Robust, and Sensitive Detection of 11-nor- $\Delta^9$ - Tetrahydrocannabinol-9-Carboxylic Acid in Hair

## Application Note

Forensic Toxicology/Doping Control

### Authors

David Engelhart  
Omega Labs, Inc.  
Mogadore, OH 44260  
USA

Fred Feyerherm,  
Stephan Baumann, and  
Bernhard Rothweiler  
Agilent Technologies, Inc.  
Santa Clara CA 95051  
USA

### Abstract

A robust method for the detection of the THCA marijuana metabolite in hair was developed, with a run time of 7 minutes and a cycle time of 9 minutes, using column switching and backflushing. The method limit of detection (LOD) was 0.002 pg/mg and the limit of quantification (LOQ) was 0.01 pg/mg.

### Introduction

Testing hair for drugs of abuse has been practiced for over 50 years, due, in large part, to the ability to detect drug use over a longer period of time, as compared to other biological matrixes, because many drugs are well-preserved in hair. It is also commonly used to screen and monitor drug use in employees and drug treatment participants. Workplace programs include hair testing due to the ease of collection, difficulty of adulteration, and longer detection times.

Marijuana is one of the drugs tested most often in forensic and drug screening applications. The parent compound, tetrahydrocannabinol (THC), is found in higher concentration in hair samples, but detection of the acid metabolite 11-nor- $\Delta^9$ -tetrahydrocannabinol-9-carboxylic acid (THCA) is preferred, to eliminate the possibility of potential environmental contamination from marijuana smoke. While guidelines for workplace hair testing have not yet been adopted by the Substance Abuse Mental Health Services Administration (SAMHSA) in the United States, a cutoff concentration for nor-9-carboxy- $\Delta^9$ -tetrahydrocannabinol as low as 0.05 pg/mg hair has been suggested. The Society of Hair Testing recommends an LOQ of  $\leq 0.2$  pg/mg for THCA.



**Agilent Technologies**

This application note describes a method developed on the Agilent 7890A GC System coupled with an Agilent 7000B Triple Quadrupole GC/MS System that provides rapid and sensitive detection of a THC metabolite in hair, using 2-D GC and negative ion chemical ionization (CI) MS/MS in multiple reaction monitoring (MRM) mode, also called selected reaction monitoring (SRM). This method was modified from a previous GC/MSD method [1] to take advantage of the lower chemical background and higher sensitivity provided by triple quadrupole MS/MS analysis. Backflush is used to increase robustness, and low thermal mass (LTM) column modules speed the chromatography process, enabling a run time of 7 minutes and a cycle time of 9 minutes. MRM MS/MS analysis on the 7000B Triple Quadrupole GC/MS System delivers excellent sensitivity, with a LOD of 0.002 pg/mg and a LOQ of 0.01 pg/mg.

## Experimental

### Standards and reagents

Tri-deuterated THCA, which was used as the internal standard (100 µg/mL in methanol), and unlabelled THCA (100 µg/mL in methanol) were obtained from Cerilliant, (Round Rock, TX). The internal standard concentration in the method was 0.05 pg/mg of hair.

Methanol, acetonitrile, toluene, ethyl acetate, hexane, glacial acetic acid, and methylene chloride were obtained from Spectrum Chemicals (Gardena, CA). All solvents were high-performance liquid chromatography (HPLC) grade or better, and all chemicals were ACS grade. The derivatizing agents, pentafluoropropionic anhydride (PFPA) and 1,1,1,3,3,3-hexafluoro-2-propanol (HFIP), were purchased from Sigma-Aldrich (St. Louis, MO) and Campbell Science (Rockton, IL), respectively.

### Instruments

The experiments were performed on an Agilent 7890A GC System equipped with a split/splitless inlet and a LTM System, coupled to an Agilent 7000B Triple Quadrupole GC/MS System. Two dimensional chromatography was performed using a precolumn for backflushing, two low thermal mass (LTM) columns connected by a Deans Switch, and a Purged Ultimate Union (Figure 1). The instrument conditions are listed in Table 1.

Table 1. Agilent 7890A GC System and Agilent 7000B Triple Quadrupole Mass Spectrometer Conditions

<b>GC run conditions</b>	
Precolumn	1 m × 0.15 mm, 1.2 µm DB-1 (p/n G3903-61004)
<b>Analytical columns</b>	
Column 1	15 m × 0.25 mm, 0.25 µm DB-1ms LTM Column Module with long legs (p/n G3900-65002)
Column 2	15 m × 0.25 mm, 0.25 µm DB-17ms LTM Column Module with long legs (p/n G3900-65001)
Ferrules for column connections	Flexible Metal Ferrules 0.1–0.25 mm column (p/n G3188-27501)
Injection port liner	Single taper direct connect (p/n G1544-80730)
Injection volume	2 µL
Inlet temperature	Isothermal at 250 °C
Injection mode	0.75 minute pulsed splitless at 35 psi
<b>Oven temperatures</b>	
GC oven	7 minute hold at 250 °C (isothermal)
1st LTM module	50 second hold at 100 °C 100 °C to 210 °C at 200 °C/min 210 °C to 267 °C at 10 °C/min Hold at 267 °C for 2 minutes
2nd LTM module	324 second hold at 100 °C 100 °C to 230 °C at 200 °C/min 230 °C to 240 °C at 10 °C/min Hold at 240 °C for 2 minutes
Carrier gas	Helium in constant pressure mode. Precolumn: 1 psi; Column 1: 26.6 psi; Column 2: 19.6 psi
Transfer line temp	300 °C
<b>MS conditions</b>	
Tune	Autotune
EMV delta	1,200 V
Acquisition parameters	NCI mode; MRM
Reagent gas	Ammonia, 35% flow
Collision gas	Argon, constant flow, 0.9 mL/min
Quench gas	Helium, constant flow, 0.5 mL/min
Solvent delay	6.2 minutes
MS temperatures	Source 150 °C; Quadrupole 150 °C

## Sample preparation

Samples were prepared as previously described [2]. Calibrators, controls, or hair specimens (20 mg) were weighed into silanized glass tubes and washed with methylene chloride (1.5 mL). The solvent was decanted and the hair samples were allowed to dry. The internal standard, THCA-d3 (0.05 pg/mg), was added to each hair specimen. For the calibration curve, unlabelled THCA was added to the hair at concentrations of 0.002, 0.01, 0.02, 0.05, 0.1, and 0.5 pg/mg of hair.

Deionized water (0.5 mL) and 2 N sodium hydroxide (0.5 mL) were added, and the hair was heated at 75 °C for 15 minutes. The sample was allowed to cool and then centrifuged at 2,500 rpm for 15 minutes. The supernatant was poured into glass tubes containing acetic acid (1 mL), 1 M acetic acid (3 mL), and 0.1 M sodium acetate buffer (pH 4, 2 mL). The tubes were capped and mixed.

Bond Elut Certify I solid-phase extraction columns (130 mg) from Agilent, Inc. SPE columns were conditioned with hexane/ethyl acetate (75:25, v/v; 2 mL), methanol (3 mL), deionized water (3 mL), and 0.1 M hydrochloric acid (1 mL). The acidified samples were loaded onto the SPE columns and allowed to dry. The SPE columns were washed with deionized water (2 to 3 mL) and allowed to dry for 5 minutes. The SPE columns were washed with 0.1 M hydrochloric acid/acetonitrile (70:30 v/v; 3 mL) and allowed to dry at 30 psi for 10 minutes. The SPE columns were finally rinsed with hexane/ethyl acetate (75:25 v/v; 3 mL) to elute the THCA into silanized glass tubes.

The eluent was evaporated to dryness under nitrogen at 40 °C and reconstituted in PFFA (70 µL) and HFIP (30 µL) for derivatization. The mixture was transferred to autosampler vials with glass inserts and capped. The vials were heated at 80 °C for 20 minutes, then left at room temperature for 10 minutes. The extracts were evaporated to dryness in a vacuum oven. The samples were finally reconstituted in toluene (50 µL), for injection into the GC/MS system.

## Analysis parameters

The Triple Quadrupole GC/MS System parameters used are shown in Table 2.

Table 2. Agilent 7000B Triple Quadrupole GC/MS System Analysis Parameters

Compound	RT (min)	MRM	Dwell time (ms)	Collision energy (EV)
THCA*	6.714	620→492	50	5
		620→383	50	5
THCA-d3	6.710	623→495	20	5
		623→386	20	5

\*11-nor- $\Delta^9$ -Tetrahydrocannabinol-9-carboxylic acid

## Results and Discussion

### Two dimensional gas chromatography with heart-cutting

The use of two serial GC columns to separate the background from the required peak is a well-established technology that is widely used to provide excellent separation of the analyte from matrix interferences. Once the analyte retention time on the first column has been determined, the pneumatic switch (Deans Switch) is turned on to divert the flow to the second column, and turned off a short time later. This diverts a narrow, heart-cut window of the effluent from the first column that contains the analyte and minimal background, for further separation on the second column (Figure 1). The two columns function optimally when the stationary phases are as different as possible.

A unique system for rapid and robust detection of THCA in hair

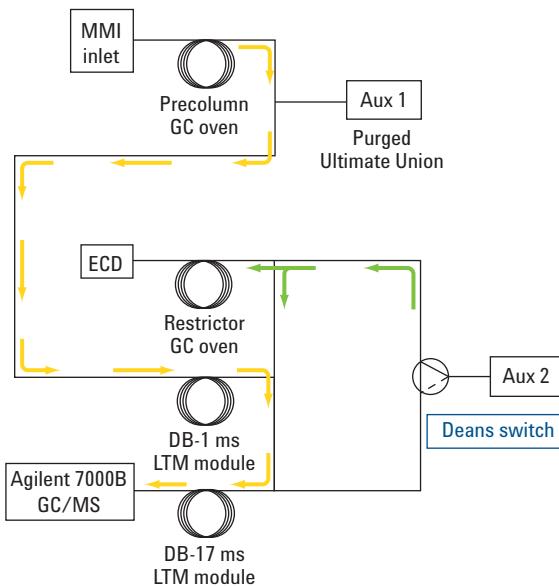

Figure 1. Schematic representation of the system used to develop the THCA method.

## Exceptional robustness and speed

The unique combination of backflushing and LTM column modules make this a very robust and rapid method, compared to the traditional single column approach. Three independently programmed pressure zones are used in conjunction with three independently heated zones (Figure 1). The precolumn and the first LTM column are coated with relatively nonpolar DB-1 ms phase, and the second LTM column is coated with a more polar DB-17ms phase. The heart-cut window is only 0.2 minutes (5.5 to 5.7 minutes) wide.

The precolumn and auxiliary pressure control module (AUX EPC) provides backflushing capability to protect and preserve the LTM analytical columns. The precolumn was in backflush mode with a constant pressure of 1 psi during the run. The inlet pressure pulse overrides the backflush for the initial 0.75 minutes. The use of backflushing prevents build-up of high-boiling compounds on the column, thus, reducing retention time shifts, peak distortion, and chemical noise, while improving quantification. Contamination of the MS source and the resultant need for cleaning are also reduced, while the run time is shortened.

This method also uses LTM column modules external to the GC oven that enable independent and optimal temperature control of the two analytical columns (Figure 2). The unique design of these modules makes it possible to use very fast temperature ramping and rapid cooling. The LTM column modules can be added to an Agilent GC without requiring any changes in the injectors, autosamplers, or detectors, and they can be controlled from the GC software.

The end result of this unique backflushing and LTM approach is a robust method that provides excellent quantification and sensitivity (see next section) with 7 minute run times and 9 minute cycle times.

## Unique LTM Column Modules enable rapid temperature ramping and cooling



Figure 2. LTM column modules interfaced with the Agilent 7890A GC.

## Sensitivity and quantification

This method has a LOD of 0.002 pg/mg, demonstrating excellent pg/mg (Figure 3). The accuracy of quantification is also quite good, with an  $R^2$  of 0.995, from 0.002 to 0.5 pg/mg of hair (Figure 4). The LOQ is 0.01 pg/mg, which is more than an order of magnitude below the 0.2 pg/mg LOQ suggested

guideline established by the Society of Hair Testing (Figure 5). This method also provides a compliant quantitative analysis report that includes the retention times (with limits), response level, qualifier ion ratio (with limits), and the calculated concentration. The total ion current (TIC) trace and the quantifier and qualifier MRM traces are also displayed on the report, for both the sample and the THCA-d3 internal standard (Figure 6).

### LOD of 0.002 pg/mg

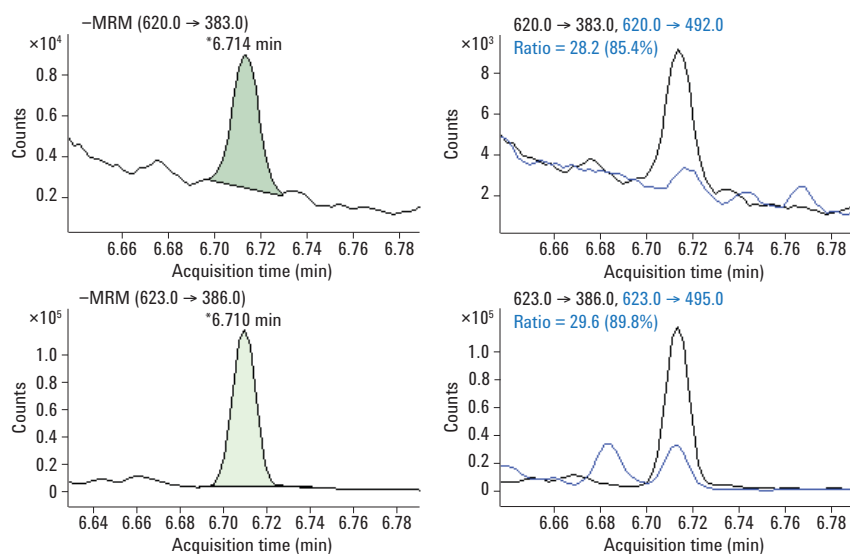

Figure 3. MRM traces for the quantifying transition (left) and both the quantifying and qualifying transitions (right) for the 0.002 pg/mg LOD of THCA (upper panel) and the deuterated standard (lower panel) spiked into a hair sample.

### Reliable calibration

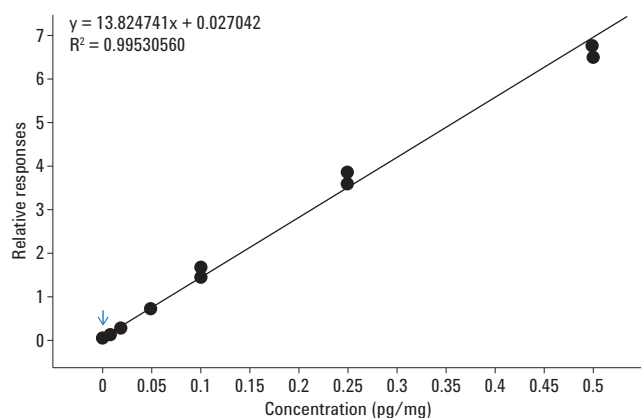

Figure 4. Calibration curve for THCA spiked into hair samples at 0.002, 0.01, 0.02, 0.05, 0.1, and 0.5 pg/mg of hair.

**0.01 pg/mg LOQ**

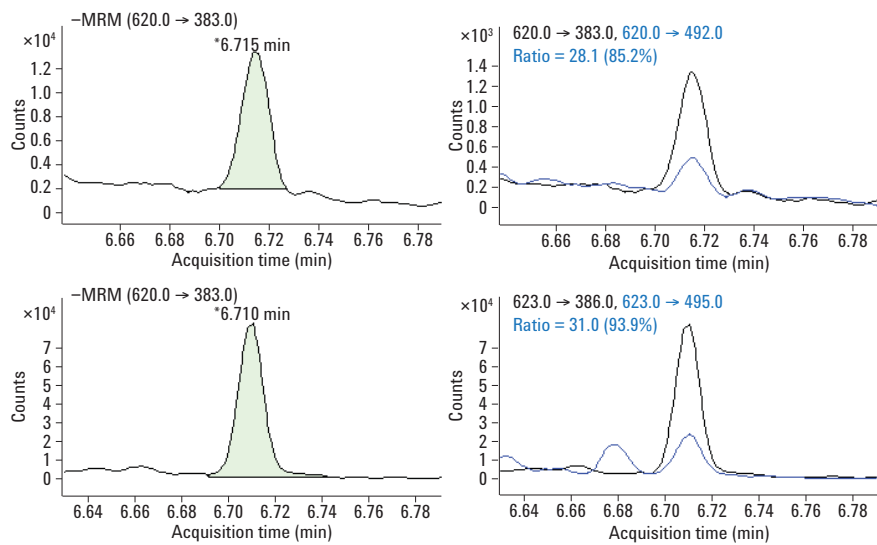

Figure 5. MRM traces for the quantifying transition (left) and both the quantifying and qualifying transitions (right) for the 0.01 pg/mg LOQ of THCA (upper panel) and the deuterated standard (lower panel) spiked into a hair sample.

Data File	01401015.D	Vial	14
Operator	DATASYSTEM01/Admin	Dilution	0.0
Acq method name		Sample information	
Acquisition date	2010-10-08 16:24	Last calib update	2010-11-28 09:34
Sample name and path	0.01 pg/mg, D:/MassHunter/GCMS/1/data/PFAA Curve Extracted/		

Compound	Signal	RT	Limits	Response	QRatio	Limits	Final conc
THCA-d3	623.0 → 386.0	6.71		82,558		35,770–143,081	
	623.0 → 495.0			24,962	30.2	23.1–42.9	
THCA	620.0 → 383.0	6.71	6.38–7.05	10,999			0.008
	620.0 → 492.0			3,908	35.5	23.1–42.9	

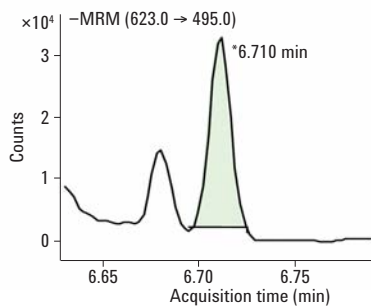
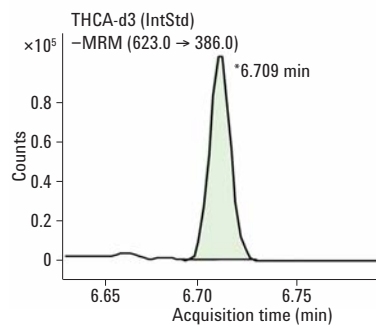
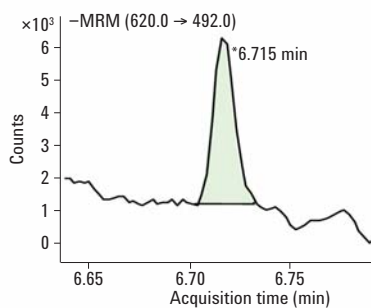
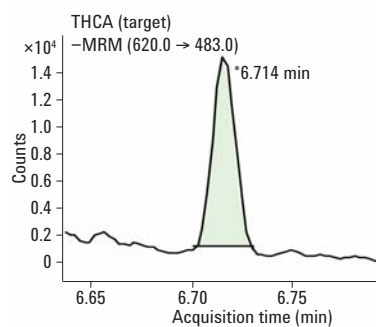
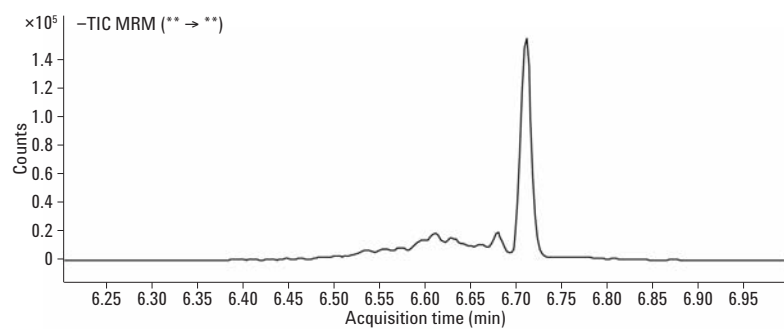

Figure 6. Quantitative Analysis Sample Report for a 0.01 pg/mg (the LOQ) sample spiked into hair.

## Conclusion

The time-proven technique of heart-cutting to improve chromatographic separation is given new life in this unique method, which uses state-of-the-art microfluidics-aided backflushing and low thermal mass column temperature ramping modules to deliver sensitive and robust detection and quantification of THCA in hair (LOD 0.002 pg/mg; LOQ 0.01 pg/mg) with run times of only 7 minutes, and cycle times of 9 minutes.

## References

1. F. Feyerherm, *et al.*, "Rapid Multidimensional GC Analysis of Trace Drugs in Complex Matrices" Gerstel publication AN-2007-8.
2. C. Moore, *et al.*, "Application of Two-dimensional Gas Chromatography with Electron Capture Chemical Ionization Mass Spectrometry to the Detection of 11-nor- $\Delta^9$ -Tetrahydrocannabinol-9-carboxylic acid (THCA) in Hair" *J. Anal. Toxicol.* **30**, 171–177 (2006).

[www.agilent.com/chem](http://www.agilent.com/chem)

For Forensic Use only.

Information is subject to change without notice.

© Agilent Technologies, Inc., 2014  
Printed in the USA  
March 31, 2014  
5990-7535EN



**Agilent Technologies**