

# **Agilent JetClean for OpenLAB**

## **Operating Manual**



**Agilent Technologies**

## Notices

© Agilent Technologies, Inc. 2017

No part of this manual may be reproduced in any form or by any means (including electronic storage and retrieval or translation into a foreign language) without prior agreement and written consent from Agilent Technologies, Inc. as governed by United States and international copyright laws.

### Manual Part Number

G7077-90118

### Edition

First Edition, September 2017

Printed in USA

Agilent Technologies, Inc.  
5301 Stevens Creek Boulevard  
Santa Clara, CA 95051

### Warranty

**The material contained in this document is provided “as is,” and is subject to being changed, without notice, in future editions. Further, to the maximum extent permitted by applicable law, Agilent disclaims all warranties, either express or implied, with regard to this manual and any information contained herein, including but not limited to the implied warranties of merchantability and fitness for a particular purpose. Agilent shall not be liable for errors or for incidental or consequential damages in connection with the furnishing, use, or performance of this document or of any information contained herein. Should Agilent and the user have a separate written agreement with warranty terms covering the material in this document that conflict with these terms, the warranty terms in the separate agreement shall control.**

### Safety Notices

#### CAUTION

A **CAUTION** notice denotes a hazard. It calls attention to an operating procedure, practice, or the like that, if not correctly performed or adhered to, could result in damage to the product or loss of important data. Do not proceed beyond a **CAUTION** notice until the indicated conditions are fully understood and met.

#### WARNING

A **WARNING** notice denotes a hazard. It calls attention to an operating procedure, practice, or the like that, if not correctly performed or adhered to, could result in personal injury or death. Do not proceed beyond a **WARNING** notice until the indicated conditions are fully understood and met.

# Contents

## 1 Introduction

- General Concept 6
- Two Modes of Operation 7
- Which Mode Should You Use? 8
- Configure the MS in OpenLAB 9
- Configure a CI Source With JetClean 12
- Configure an HES or EI Source With JetClean 13
- Configure an HES or EI Source Without JetClean 14

## 2 Clean Only Mode

- Concept 16
- Running the Clean Only Mode, After a Batch of Samples – Concept 20
- Running the Clean Only Mode, After Running Each Sample – Concept 21
- Optimize Parameters (Setpoints) 21
- Create and Run a JetClean Clean Only Method 28

## 3 Acquire & Clean Mode

- Concept 34
- Running JetClean in the Acquire & Clean Mode 35
- Create and Run a JetClean Acquire & Clean Method 36

## 4 Troubleshooting

- General Troubleshooting 42
- Troubleshooting JetClean 43

## 5 Hardware

Intended Use	46
Supported Systems	46
System Operation and Maintenance	47
General warnings	47
Hydrogen supply plumbing	48
Equipment Precautions	49
Operating Precautions	50
Hydrogen Plumbing	51
General recommendations	51
Supply tubing for hydrogen gas	52
Hydrogen supply systems	52
Pressure regulator gas supply tubing connections	53
Changing the Hydrogen Supply Filter	54
Manually Cleaning the Ion Source	55
General Laboratory Precautions	55

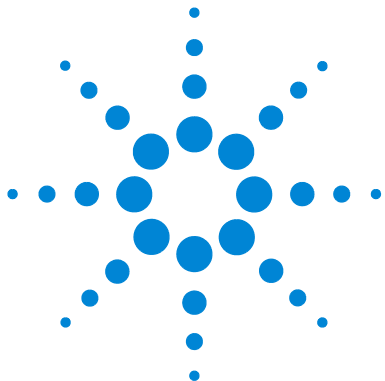

# 1 Introduction

General Concept	6
Two Modes of Operation	7
Which Mode Should You Use?	8
Configure the MS in OpenLAB	9
Configure a CI Source With JetClean	12
Configure an HES or EI Source With JetClean	13
Configure an HES or EI Source Without JetClean	14

The Agilent JetClean system allows you to greatly increase the number of samples you can process before you must manually clean your ion source. This chapter provides a brief concept of how the JetClean system works.



## General Concept

During the JetClean process a small amount of hydrogen is introduced into the ion source's ion volume while the filament is emitting electrons: reactive hydrogen species are created. Each time this process runs, contamination is removed from the ion source depending on the conditions and the nature of the contamination. Consequently:

- Background is reduced (chemical noise)
- “Lost” compound detection limits can be recovered
- Manual cleaning will be required less frequently

However, over time, in spite of the JetClean process, less reactive contaminants may build up on the ion source optics, and the source will then have to be manually cleaned. By careful application of the process and use of the parameters for JetClean, this manual process can become much less frequent.

## Two Modes of Operation

The JetClean application can be applied in one of two modes:

- **Clean Only** mode – In this mode, the hydrogen is introduced into the system after the sample(s) have been processed. When you use this mode, you would create a new method which will be used in the JetClean process, while your existing sample processing methods would remain unchanged.
- **Acquire & Clean** mode – In this mode, samples are analyzed via GC/MS EI while a small amount of hydrogen is simultaneously introduced into the ion volume to remove and reduce contaminants. When you use this mode, you would modify your existing acquisition methods to include a low flow of hydrogen suitable to your application.

Each mode offers advantages and disadvantages, based on the variables in your system, such as:

- The samples you are processing and their degree of cleanup, contamination, and matrix
- The analytes you target
- Your existing Standard Operating Procedures
- Your current workflow or sample batches

Other considerations that will become clear as you gain an understanding of JetClean.

## Which Mode Should You Use?

To decide which JetClean mode (Clean Only or Acquire & Clean) is best for you, you must consider the variables specific to your system (such as sample type and cleanup effectiveness, and the analyte's chemistry, for example) and evaluate the impact each mode would have on your work flow.

Although each situation is different, some of the major items to consider are listed below.

**1** What compounds are you analyzing?

**Polar compounds**, compounds containing oxygen, nitrogen, sulphur, or phosphorus, may react with trace (trickle) hydrogen flow provided by the JetClean process to compromise your detection limits or spectral matches. In this case, the Acquire & Clean mode may not be acceptable. The Clean Only mode may be a better solution.

**Non-polar compounds**, and other highly stable compounds (PAHs, PCBs, etc.) on the other hand, will have limited reactivity in hydrogen, and therefore may work well with the Acquire & Clean mode.

**2** Will you need to modify your Standard Operating Procedures?

When you use the Acquire & Clean mode, you will need to modify your GC/MS analytical methods by including hydrogen during sample analysis. If your methods are included in validated SOPs, you may, therefore, need to modify and revalidate your SOPs.

On the other hand, the Clean Only mode will not require a new acquisition method, and, depending on your in-house operations, it may only be an addition to your system maintenance SOPs. However, the existing acquisition methods and SOPs could remain unchanged, and would not need to be revalidated.



## Configure the MS in OpenLAB

To configure the MS instrument:

- 1 Add the MS to the Control Panel.
- 2 Be sure the instrument is turned on and connected to the same network as your OpenLAB Control Panel.
- 3 In the Control Panel, with your instrument selected (GCMS 12 in [Figure 1](#)), click **Configure Instrument**.

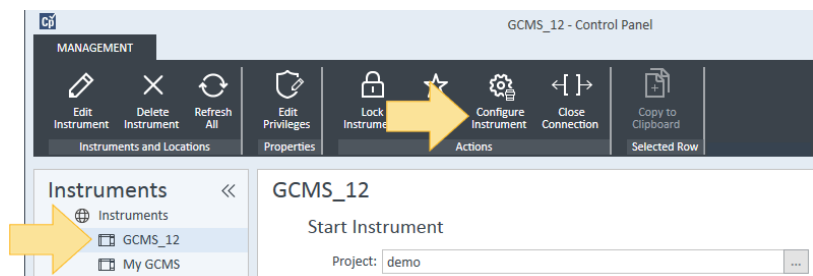

**Figure 1** OpenLAB control panel

- 4 Double-click **Agilent 597x MSD**, then double-click **Agilent 597x MSD (Unconfigured)**. (See [Figure 2](#).) This displays the configuration box. (See [Figure 3](#) on page 10.)

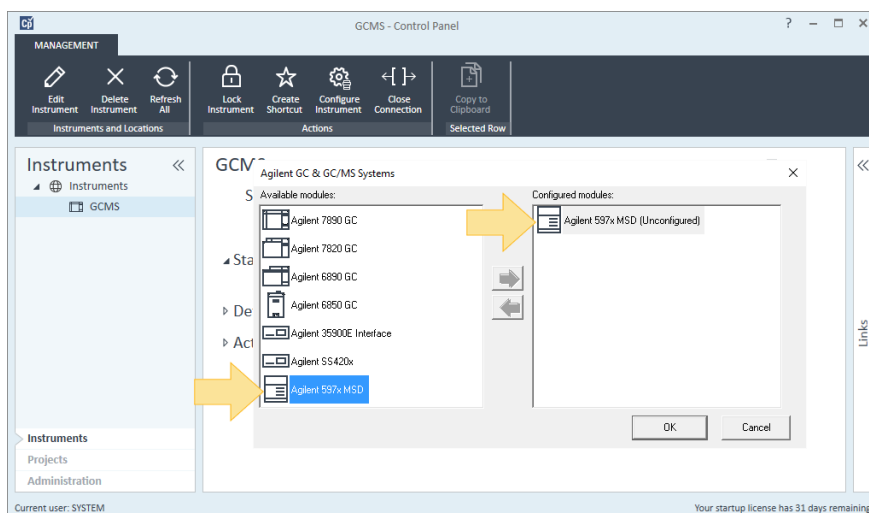

**Figure 2** Configure instrument control panel

- 5 Enter the **IP Address** for this instrument in the highlighted box.

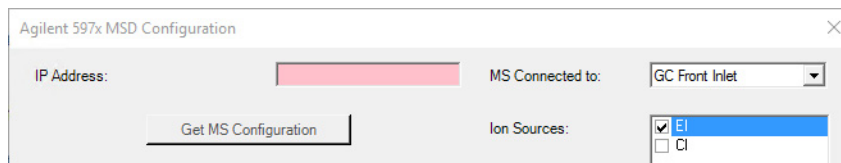

**Figure 3** Configuration box

- 6 Click **Get MS Configuration**.
- 7 Verify that the column is configured to the correct inlet. If your MS is not configured with a GC, be sure to select **Other** for this box.
- 8 Select the **ion source** currently installed in your instrument (EI, CI, HES).
- 9 Verify the **Quad DC Polarity**, as noted on the analyzer side door, is correct for this source.
- 10 Click **Gas Control Configuration** to define your controller type and gas configuration. (See [Figure 4](#).)

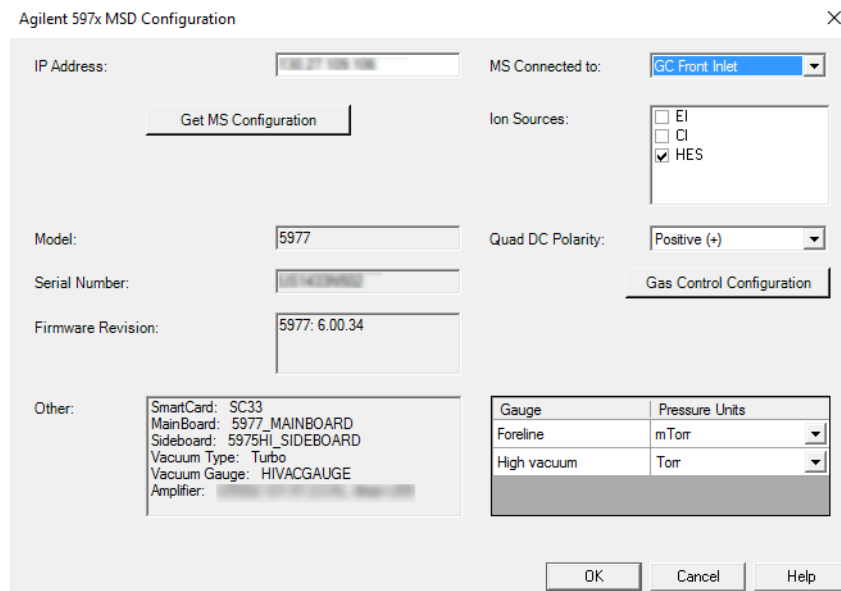

**Figure 4** Gas control configuration

- 11** The Gas Control Configuration dialog you see will be based on the source you identified.

For details on configuring your specific ion source, see one of the following:

- “Configure a CI Source With JetClean” on page 12
  - “Configure an HES or EI Source With JetClean” on page 13
  - “Configure an HES or EI Source Without JetClean” on page 14
- 12** After completing the Gas Control Configuration, you are returned to here once again. Click **OK** to complete the configuration.

## Configure a CI Source With JetClean

For a CI Source, you will see a dialog similar to the one shown in [Figure 5](#). To configure the instrument **to use the JetClean function**:

- 1 **JetClean - EI/CI system** is automatically selected. The **None** and **JetClean - EI only system** are not available.
- 2 For **Channel A**, select the CI reagent gas.
- 3 For **Channel B**, select:
  - **Hydrogen** if you are using a **JetClean** system.
  - An **alternate** CI reagent gas if you are not using a JetClean system.
- 4 If you selected **Hydrogen** for Channel B, enter the time in minutes that the hydrogen gas should be shut off when inactive. (This example shows 10 minutes.)
- 5 If you select **Other** in either Channel A or B, enter the appropriate gas name in the location provided.
- 6 Click **OK** to return to the 597xMSD Configuration dialog.

Gas Control Configuration

**Controller Type**

None

JetClean - EI only system

CI/JetClean - EI/CI system

---

**Gas Configuration**

Channel A gas:  Other:

Channel B gas:  Other:

Turn off hydrogen gas if inactive (min):

**Figure 5** Controller Type - CI/JetClean - EI/CI system

## Configure an HES or EI Source With JetClean

For an EI or HES Source, you will see a dialog similar to the one shown below. To configure the instrument to use the **JetClean** function:

- 1 Select **JetClean - EI only system**. The Gas Configuration automatically changes to configure Channel A as **None**, and Channel B as **Hydrogen**. These cannot be changed. (See [Figure 6](#).)
- 2 Enter the time in minutes that the hydrogen gas should be shut off when inactive. (This example shows 10 minutes.)
- 3 Click **OK** to return to the 597xMSD Configuration dialog.

Gas Control Configuration

**Controller Type**

None

JetClean - EI only system

CI/JetClean - EI/CI system

---

**Gas Configuration**

Channel A gas: None (dropdown) Other: [text box]

Channel B gas: Hydrogen (dropdown) Other: [text box]

Turn off hydrogen gas if inactive (min): 10

OK Cancel Help

**Figure 6** Controller Type - JetClean EI only system

## Configure an HES or EI Source Without JetClean

For an EI or HES Source you will see a dialog similar to the one shown below. To configure the instrument to **work without using the JetClean function**:

- 1 Select **None**. The channel A and channel B configurations options are set to **None** and cannot be modified. (See [Figure 7](#).)
- 2 Click **OK** to return to the 597xMSD Configuration dialog.

Gas Control Configuration

**Controller Type**

None

JetClean - EI only system

CI/JetClean - EI/CI system

---

**Gas Configuration**

Channel A gas  Other

Channel B gas  Other

Turn off hydrogen gas if inactive (min)

OK Cancel Help

**Figure 7** Controller Type - None

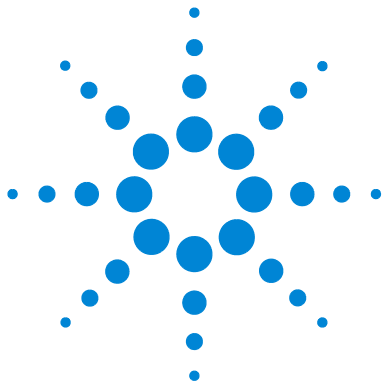

## 2 Clean Only Mode

Concept 16

Running the Clean Only Mode, After a Batch of Samples – Concept 20

Running the Clean Only Mode, After Running Each Sample – Concept 21

Optimize Parameters (Setpoints) 21

Create and Run a JetClean Clean Only Method 28



### Concept

The JetClean **Clean Only** mode is independent of your standard sample acquisition, and uses a completely different and separate method than your sample acquisition method(s). You do not need to modify your existing sample acquisition methods at all.

The JetClean **Clean Only** mode requires an investigation to determine the number of samples that can be run before running the JetClean **Clean Only** method and what parameters to apply in the JetClean method. In general, all analysts experience the same general trend. When the system is clean and leak-tight, compound responses and detection limits remain suitable as samples are running. At some point detection limits begin to suffer and maintenance is required. This may be the replacement of the septum and liner, column cut back, tightening of the ferrule, etc., and detection limits are restored. Careful examination of autotune files can reveal issues specific to the source beyond leaks or GC related problems. Typically, this is the time the source would require baking, updating the gain factors, or manual cleaning. Before the system has reached this stage the analyst, based on their experience, could apply a short and light JetClean **Clean Only** method to head off source degradation. In fact, one way to consider the JetClean **Clean Only** method is as an additional tool analogous to baking the source to remove contamination. The JetClean **Clean Only** method is far more effective than baking alone. An illustration of the situation is given in [Figure 8](#) on page 17.



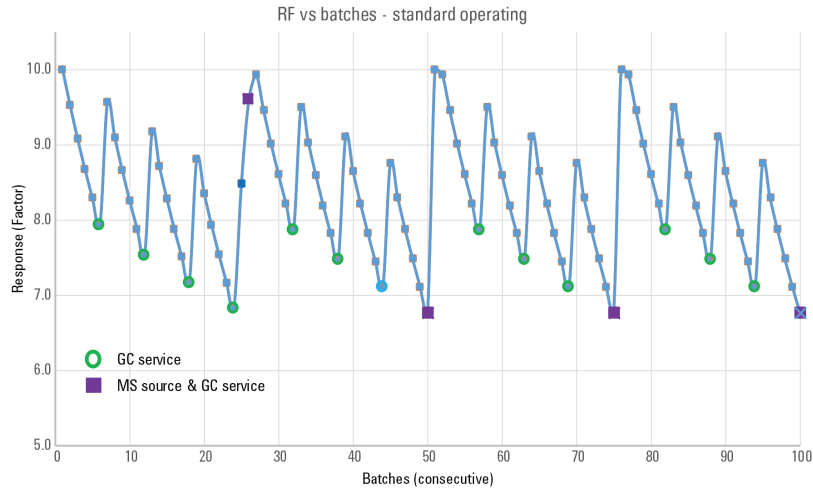

**Figure 8** Response factor versus batches – Standard operating conditions

Figure 8 shows the analytical situation for the results of the response of a standard as the course of sequential sample batches are being run. From the left to the right, as the number of sample batches are acquired, there is a clear decay in response (factor) proceeding from the starting response (at 0) and through to the 6th set. By the 6th set, the response had dropped  $> \sim 20\%$  and indicates GC servicing is necessary which is marked in the figure as a (green) circle (probably not using rapid intra-column backflush).

After the GC maintenance, response has returned but not to the prior value (of 10 for batch 0). This signifies that some degradation of the source (and its contribution to) response has occurred.

Another 6 sets are acquired and another GC maintenance takes place (at batch 12), and this continues through batches 18, and 24.

However, after maintenance at batch 24, the 25<sup>th</sup> batch shows a lower response by  $> \sim 15\%$  than initial response which is deemed unacceptable and so the MS is vented and the source cleaned, which is indicated by the square marker at batch 26.

Response nearly returns and as the source is “shot in” by continued injections it returns to the initial response at batch 0.

## 2 Clean Only Mode

The sequence of batches continues with GC servicing every 6 batches consistent with the response loss until both a GC service and MS source cleaning must be conducted at batch 50, 75 and so on.

Figure 9 shows the situation as before, but with the JetClean **Clean Only** mode operating after each batch.

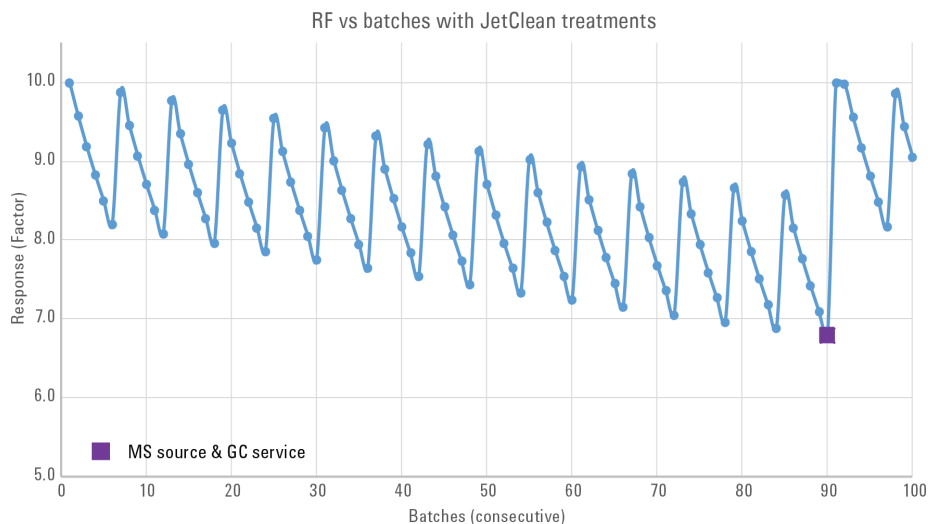

**Figure 9** Response factor versus batches with JetClean **Clean Only** mode after each batch

GC maintenance is still required every 6 batches (not indicated but visible as before), but now GC and MS maintenance is not required until after batch 90; from every 25 batches to 90 batches – a substantial decrease in MS servicing. This illustrates what JetClean can offer.

It is important to note that this control chart approach, although widely applied, is not strictly correct and often misleading. In the same way that Signal-to-noise is not a good metric, this approach should be replaced by one that focuses on method detection limits.

Depending on the results of the investigations of your samples and required maintenance frequency, you may implement the JetClean **Clean Only** mode:

- After running a batch of samples
- After running a single sample (if degraded performance is seen immediately after such a sample is acquired)

The next section describes a little bit more about this concept. Investigative testing will help determine a solution that is best for extending the ion source manual cleaning cycle when running specific sample types.

It is important to recognize that JetClean is not a replacement for things such as proper sample preparation or maintenance of GC issues such as leaks, and users should consider implementing (rapid, intra-column) backflushing (Agilent G1472A Universal GC/MS PCT Backflush Kit) which has shown the greatest reliability in preventing source related degradation of compound detection limits.

### Running the Clean Only Mode, After a Batch of Samples – Concept

The following describes the general procedure you would follow to apply the JetClean **Clean Only** mode after running a batch of samples.

- 1 Create a standard JetClean **Clean Only** acquisition method.  
Start with the lightest conditioning method, which will be described below.
- 2 Run your samples as usual with your standard sample acquisition method.
- 3 When you observe signal loss, or background noise, perform your standard troubleshooting routine (GC liner and column maintenance, leak test, gain factor update, analyzer bakeout, autotune, etc.). (See “[Troubleshooting](#)” on page 41.)
  - a If, after routine troubleshooting and maintenance, the signal is restored, or the background noise is removed, resume processing samples as usual.
  - b If the troubleshooting did not improve the results, run the JetClean **Clean Only** method.
- 4 After running the JetClean **Clean Only** method, run a sample to see how effective the JetClean application was.
  - a If the results have improved satisfactorily, resume processing samples as usual.
  - b If the results have improved, but not sufficiently, adjust the setpoints of the JetClean **Clean Only** method, very slightly, and re-run the JetClean method. (For example, increase the amount of hydrogen added or the exposure time.)
  - c If the results have gotten worse, it may be time to perform a manual cleaning. It may also be another issue which is common to cleaned sources and will be discussed later in the document.

It is important to note that “the results” refers to the ability of the system to detect compounds of interest (not signal alone nor S:N!), as well as considerations of spectral fidelity, system background, etc.

## Running the Clean Only Mode, After Running Each Sample – Concept

Generally speaking, to run the JetClean **Clean Only** mode after running each sample, you would do the following:

- 1 Create a very short running JetClean **Clean Only** method intended to run after each sample run.
- 2 Run sample 1 with your normal sample acquisition method, as usual.
- 3 Run the JetClean method.
- 4 Run sample 2, as usual.
- 5 Run the JetClean method.
- 6 Continue alternately running the JetClean method and normal samples until you observe detection limits rising.
- 7 When you observe this, perform your standard troubleshooting and maintenance routine (leak test, gain factor update, bakeout, autotune). (See “[Troubleshooting](#)” on page 41.)
  - **If your results improved**, resume alternately processing samples and running the JetClean method, as above.
  - **If your results did not improve**, it may be time to manually clean your ion source or decrease or increase the intensity of the JetClean method.

## Optimize Parameters (Setpoints)

Hydrogen can be harsh on the filament so the JetClean **Clean Only** method uses filament number two, leaving the analytical filament to be filament number one. (In CI operation there is only one filament available.)

To obtain the best possible sample throughput with minimal source impairment, during the development of your JetClean **Clean Only** method, there are several parameters you can adjust, test, and readjust to obtain optimal results. Some of these parameters include:

- Time
- Hydrogen flow
- Emission
- Source temperature
- Number of samples between JetClean applications

## 2 Clean Only Mode

- Type of samples
- Etc.

It is important to obtain the lowest possible hydrogen flow, while still observing good results. To begin, start by using the lowest setting you feel will be effective. If the results are not satisfactory, increase the flow and retest.

- **Too little hydrogen** will fail to clean the source sufficiently.
- **Too much hydrogen** will “over condition” the source – a topic that will be discussed later.

Applying the **Clean Only** process, either manually or as a method run in a sequence, creates a scan datafile of the conditioning process. This datafile contains valuable information that provides insight into the degree of conditioning.

### NOTE

The method should be configured to collect this scan data over a range suitable to the instrument – this is described below.

---

Figure 10 shows an example of the EIC for such a collected JetClean **Clean Only** datafile on a 5977B with HES source. The extracted ions of 55, 57, 91 are examples of ions indicating the background contamination; 55 and 57 reflect the hydrocarbons and 91 aromatics, etc.

Notice the ions indicate not all species have exactly the same kinetics nor initial or final abundancies. You can determine which degree of treatment is suitable for your compounds and your analysis.

Note the possibility of a rapid light treatment for  $\sim 1.5$  minutes, more extensive for  $\sim 3.5$  minutes, or an even longer duration. By manipulating the parameters, short periods of treatment can be used to remove varying degrees of contamination.

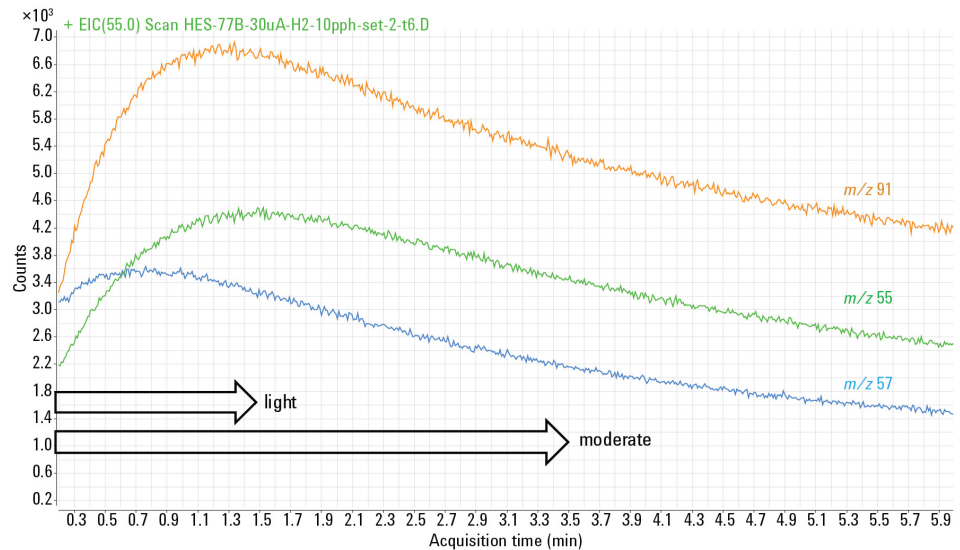

**Figure 10** EICs for JetClean Clean Only mode for 5977B SQ-HES over the range of 0 to 6-mins

The approach to exploring this is sequential in the following logic.

Starting with the default parameters, treat a contaminated source and then continue operating. If it is judged insufficient, first extend the time of the treatment and continue to increment the time to about a 10-minute run time. At that stage treatments are becoming too long in duration so shorten the time back to 1 or 2 minutes and increase the hydrogen flow by doubling or tripling

the amount. Continue this until the hydrogen flow setpoint nears half the recommended maximum flow for that source type. Then reduce the time and flow back and increase the emission.

The last parameter to be implemented is increasing source temperature. This is helpful in removing very recalcitrant deposits but adds additional time to the process as the source must cool to the operating temperature, so typically it is a last resort.

Like standard manual cleaning, there is a period where the analyzer must stabilize. After manual cleaning, the process is baking and retuning, but for the JetClean **Clean Only** mode, there are other additional approaches, the most successful of which is to “shoot the analyzer in”. Instead of the alternative of a long stabilization time setting, a short setting there is made up for by several injections of standards or matrix or analyte protectants (as in pesticide applications) which stabilize the system. Retuning should be applied again at the end of this process and before sample batches are submitted.

It is possible to “over-condition” a source which results in peak tailing for compounds that are not associated with GC issues. Note these circumstances and JetClean **Clean Only** parameters, and avoid them in the future.

Table 1 on page 25, Table 2 on page 25, and Table 3 on page 26 give defaults and ranges of the important parameters. Refer to these tables while you develop your own JetClean “Clean Only” method.



**Table 1** Range of 5975, 5977A/B, and 7000A/B/C/D JetClean parameters

<b>Parameter / Starting Setpoint</b>	<b>Lower end</b>	<b>Upper end</b>	<b>Comment</b>
Hydrogen Flow: Clean Only mode 0.67 mL/min	0.13 mL/min	3.52	Flow steps are in 0.069 sccm units. The standard 3 mm Drawout lens configuration should not require more than ~3.5 mL/min in any Clean Only mode setpoint.
Emission ( $\mu$ A) 10 $\mu$ A	10	35	Emission and flow increases have the greatest effects in accelerating source cleaning. To keep times short, increment these two parameters.
Duration (min) 1 min	1 min	120	Although the upper limit is high, an advantage in JetClean is time savings, so more aggressive parameters should be explored.
Source temperature Use operating Tune file setting.	150 °C	350 °C	Start with your acquisition method's Tune File source temperature to save time. Same for the Quadrupole temperature.
Hydrogen Flow: Acquire & Clean mode 0.13	0.13 mL/min	0.49 mL/min	Most applications will use very low settings for the Acquire & Clean mode (<0.5 mL/min) and step up this parameter in small increments.

**Table 2** Range of 5977B HES and 7010 HES JetClean parameters

<b>Parameter / Starting Setpoint</b>	<b>Lower end</b>	<b>Upper end</b>	<b>Comment</b>
Hydrogen Flow: Clean Only mode 0.67 mL/min	0.13 mL/min	3.52	Flow steps are in 0.069 sccm units. No setpoint should exceed ~3.5 mL/min in any Clean Only method setpoint.
Emission ( $\mu$ A) 10 $\mu$ A	10	100	Recommended maximum is 50 $\mu$ A; low setpoints will take some time to stabilize.
Duration (min) 1 min	1 min	120	Although the upper limit is high, an advantage in JetClean is time savings, so more aggressive parameters should be explored.

**Table 2** Range of 5977B HES and 7010 HES JetClean parameters (continued)

Parameter / Starting Setpoint	Lower end	Upper end	Comment
Source temperature. Use operating Tune file settings.	150 °C	350 °C	Start with your acquisition method's Tune File source temperature to save time. Same for the Quadrupole temperature.
Hydrogen Flow: Acquire & Clean mode	0.13 mL/min	0.53 mL/min	

**Table 3** JetClean Clean Only mode scan parameters per instrument and source type

Parameter	5975 5977A/B	5977B HES 7000A/B/C/D	7010A HES 7010B HES
• eV	70 eV	70 eV	70 eV
• Gain Factor*	1	0.2	0.2
• Mode	Scan	Scan / MS1 Scan	MS1 Scan
• Starting mass†	29	29 / 45	29 / 45
• Ending mass	300	300	300
• Time / samples	2^5	2^5 / 250 msec (5)	250 msec (5)
• Threshold	25	25	25

\* The Gain Factor should be adjusted based on the parameters to keep total counts < 10<sup>5</sup> for any one ion current (an EM saver should be on). As the current and H<sub>2</sub> flow are increased, ion counts will increase.

† Starting mass at 29 will show the presence of N<sub>2</sub>H<sup>+</sup> which will indicate H<sub>2</sub> is on and the process is operating. After that, the lower mass should be raised to encompass the interesting range, perhaps 50 and above, but here the lower edge of 45 (above CO<sub>2</sub>) is cited.

**Table 4** Clean Only mode - Default method parameters

Method	Type	H2 Flow	Emission	Filament	Source	Analyzer	Time	Stabilization
CleanOnly.atune.m	Clean Only mode	0.7	20	2	230	150	1.3	10
CleanOnly.etune.m	Clean Only mode	0.7	20	2	230	150	1.3	10
CleanOnly.HES_Atune.m	Clean Only mode	0.7	10	2	230	150	1.3	10
CleanOnly.El-Clsource.m	Clean Only mode	0.7	20	1	230	150	1.3	10

You may change the tune file specified in the method.

All of the methods have six MS monitors. The monitors are:

- MS Source
- MS Quad
- Cleaning Operation
- H<sub>2</sub> Flow (mL/min)
- Emission (uA)
- Filament



All of the GC monitors are turned off because the GC does not participate in the method.

The GC method is configured under Inlet and Injection Parameters as “Other/None” for the Sample Inlet and “Valve/Immediate Start” as the Injection Source. The column flow rate and other GC parameters (e.g., transfer-line, inlet temperature, etc.) can remain unchanged. To create a Clean Only method from existing GC-MS methods, be sure to make the changes to the Inlet and Injection Parameters as stated above, confirm the changes, then save the method. If the GC attempts to inject a sample during execution of a Clean Only method, these configuration parameters need to be checked.

When a method is loaded, the monitors reflect the current state of the instrument. When the method is run, the parameters in [Table 4](#) will prevail. The **Cleaning and Stabilization** times (post run time) may be monitored by viewing the **Retention Time Clock**.

### Create and Run a JetClean Clean Only Method

In order to create and run a JetClean method, your MSD must be equipped with, and configured for a JetClean or CI flow gas controller, and Hydrogen gas must be connected to port B.

- 1 Click **Method**  then open  a method that you would use to do a normal chromatographic run.
- 2 Save the current Acquisition as a new file  .
- 3 Click **JetClean**, and from the **Operation** drop-down, select **Clean Only**. This option will not be available if your MSD is not configured for a JetClean gas controller. (See Figure 11.)

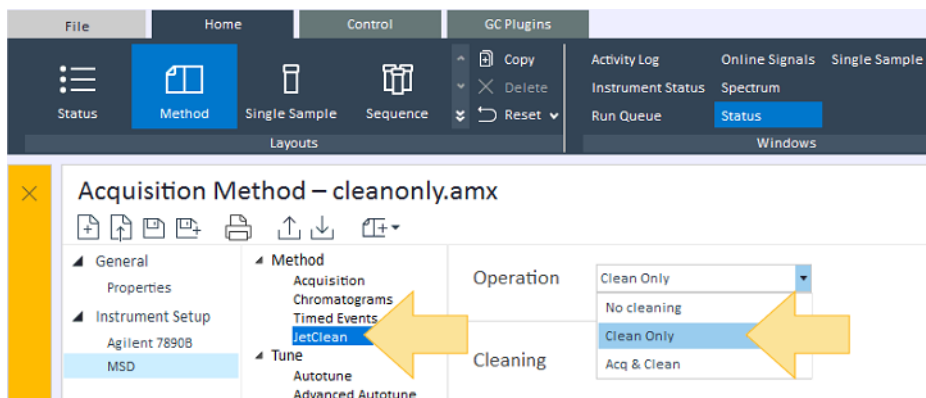

**Figure 11** Clean Only JetClean method

- 4 When developing your **Clean Only** method, it is important to obtain the lowest possible hydrogen flow, while still observing good results.
  - Too little hydrogen will fail to clean the source sufficiently.
  - Too much hydrogen will “over condition” the source.

To begin, use these default parameters for your JetClean **Clean Only** method. (See Figure 12 on page 29.)

The screenshot shows the 'Acquisition Method – cleanly.amx' window in the software. The left sidebar contains a tree view with categories: General (Properties), Instrument Setup (MSD), Method (Acquisition, Chromatograms, Timed Events, JetClean), Tune (Autotune, Advanced Autotune, Custom Tune, Manual Tune (Parameters, Acquisition, Gas Control)), and Maintenance (Vent/Pump Down, Bakeout, Purge Cal Valve, Service). The 'JetClean' option is selected. The main area shows the 'Operation' dropdown set to 'Clean Only'. Below this, the 'Cleaning' section contains a table of parameters:

Hydrogen flow (mL/min)	0.13
Filament	2
Emission	10
Source Temperature (C)	230
Quadrupole Temperature (C)	150
Duration (min)	1.3

Below the 'Cleaning' section is the 'Post Cleaning' section, which includes a note: 'For Post Cleaning, the Source and Quadrupole temperature are derived from the temperature settings in the Tune File associated with this method.' and a 'Stabilization duration (min)' field set to 10.

**Figure 12** JetClean Clean Only default parameters

- 5 Select **Instrument Setup > GC > Oven** and modify the **Hold Time** and **Post Run Time** to correspond with those set in the MSD JetClean Cleaning window (1.3 minutes in the example shown in [Figure 13](#) on page 30.).

## 2 Clean Only Mode

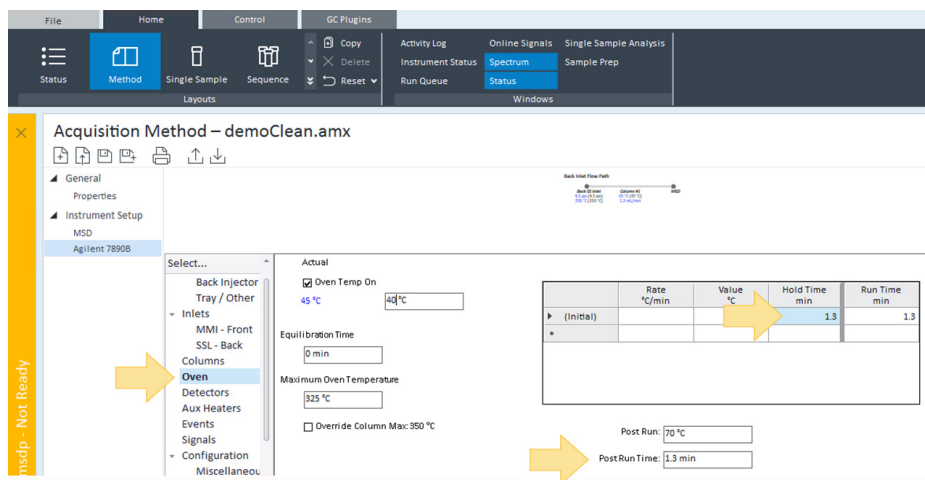

**Figure 13** Hold Time and Post Run Time settings

- 6 Save  the method. Both the GC and MS parameters, along with the method description, are saved with the method.
- 7 Access the **Single Sample** window.
- 8 For **Injection source**, select **No Injection/Instrument Blank**. This mode tells both the GC and the MS to run the specified method, even though no sample has been included. (See [Figure 14](#) on page 31.)
- 9 To begin the cleaning process, click **Run**.

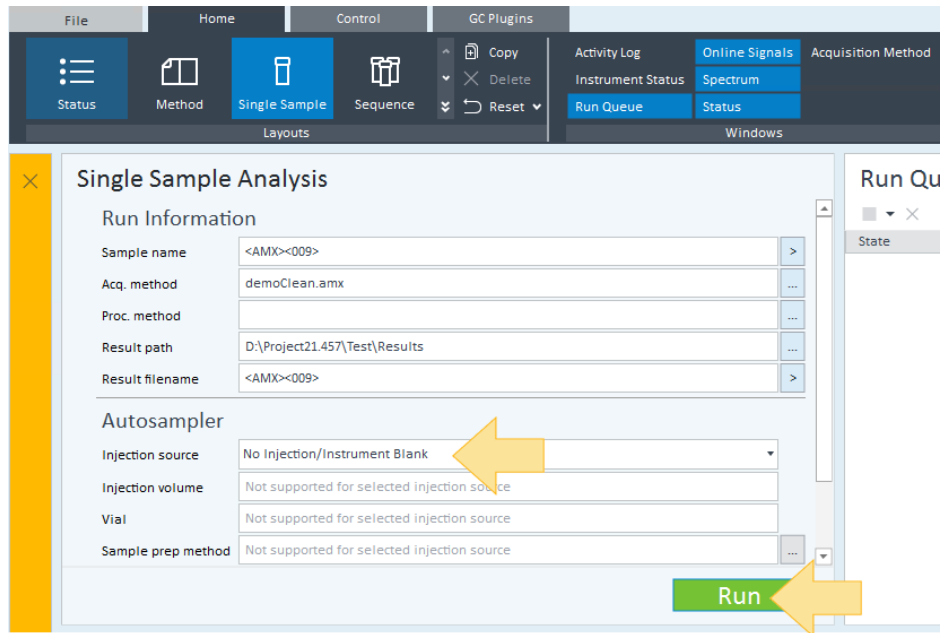

**Figure 14** Single Sample window

**10** From the Dashboard you can monitor the status of your instrument from the countdown timer, highlighted in [Figure 15](#).

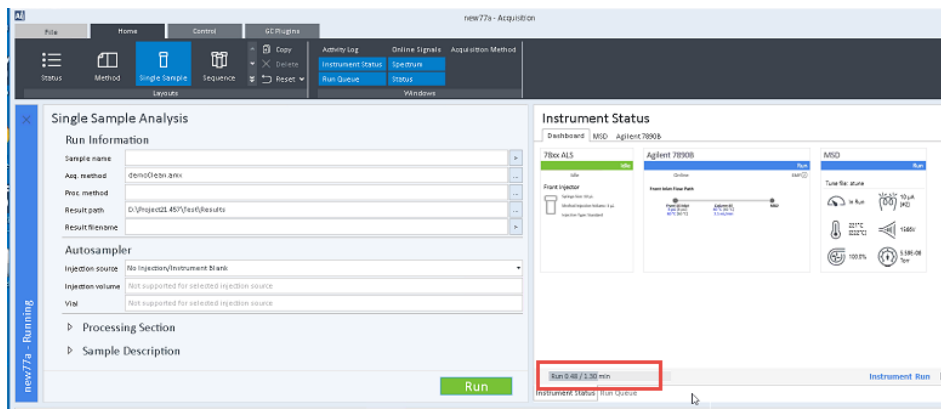

**Figure 15** Countdown timer

Additionally, you can monitor the status of your instrument on the **MSD** details page.

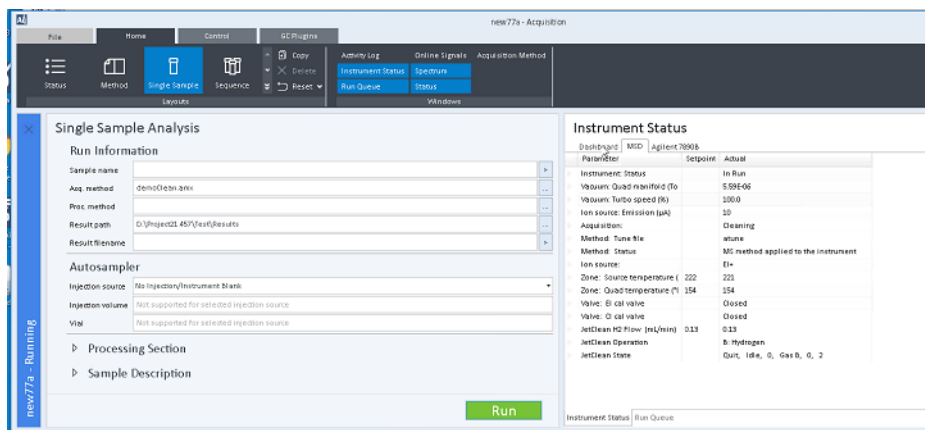

**Figure 16** MSD details page

- 11 During the stabilization time, the instrument will return to the normal method setpoints. When the process completes, review your results.

If the **results have improved satisfactorily**, resume processing samples as usual.

If the **results have improved, but not sufficiently**, adjust the setpoints of the JetClean Clean Only method, very slightly, and re-run the JetClean method. (For example, increase the amount of hydrogen added or the exposure time.)

If the **results have gotten worse**, it may be time to perform a manual cleaning.



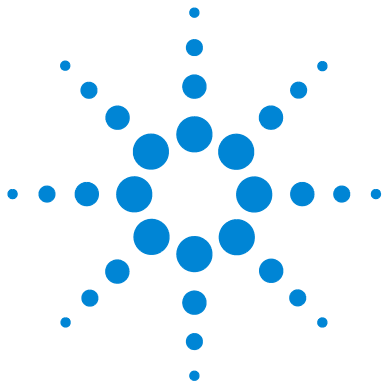

### 3 Acquire & Clean Mode

Concept 34

Running JetClean in the Acquire & Clean Mode 35

Create and Run a JetClean Acquire & Clean Method 36



## Concept

Without JetClean, during normal operations, each time a sample is processed some amount of contamination will be deposited on the ion source. Over time, this builds up to the point at which the system must be shut down and the ion source must be manually cleaned.

When you use JetClean in the **Acquire & Clean** mode, each time a sample is analyzed a small amount of hydrogen is introduced into the system along with it. Once the hydrogen reaches the ion source, a chemical reaction takes place that will remove some, but not all, sample contamination from the source. Over time you will still need to manually clean the ion source. However, by removing a small amount of contamination from the source each time a sample is processed, you will greatly increase the amount of samples you may process before you need to perform a full manual cleaning of the ion source.

Because this process requires a modified sample processing method, there are some things to consider before proceeding.

- **If you are testing Non-polar compounds**, i.e., not containing oxygen, nitrogen, sulfur, or other highly polar groups, which show little or no reactivity with hydrogen, the JetClean **Acquire & Clean** mode may be able to be incorporated into your workflow.
- **If you are testing polar compounds**, i.e., containing oxygen, nitrogen, sulfur, or other highly polar groups, which may show reactivity with hydrogen, verify that the introduction of hydrogen still allows you to meet your qualitative and quantitative requirements. If not, it may be better to work with the JetClean **Clean Only** mode.
- Because your sample processing method will be modified, it may need to be revalidated. The Clean Only mode, on the other hand, does not modify your existing sample processing method.

### WARNING

**If chlorinated solvents are used with this process you must insure the solvent delay is sufficient. Not eliminating solvent, and operating JetClean concurrently, could void the warranty of the GC/MS system.**

---

Carefully check that all solvent has eluted or been eliminated before the filament is engaged. Some examples of solvents that are most critical to eliminate prior to the filament being lit are:

- Dichloromethane (DCIM)
- Chloroform
- Carbon tetrachloride
- Carbon disulphide

## Running JetClean in the Acquire & Clean Mode

Generally speaking, the JetClean online processing workflow will be similar to the following.



- 1 Create your JetClean **Acquire & Clean** analytical method.
  - a Start with a clean ion source.
  - b Modify your sample processing method to include the smallest amount of hydrogen.
  - c Run standards as usual and observe the results. It may be that the Gain Factor(s) or even ion ratios may need to be re-adjusted.
    - If the compound results are satisfactory (i.e., the compound ion signals are not degraded or compromised by new ion interferences, and there is no compound tailing or other chromatographic problems for example), consider increasing the hydrogen and again review the results. The objective is to use the highest hydrogen flow that does not compromise the results as this will provide the most robust source conditioning.
    - If the results have gotten worse, and no longer meet the analytical criteria, and no hydrogen flow can be added during analysis, consider the Clean Only mode.
  - d When the **Acquire & Clean** method seems to be running smoothly, begin analyzing samples as usual.
- 2 Acquire the samples using the JetClean **Acquire & Clean** method. As long as your results are acceptable, continue running samples as usual.
- 3 When you observe signal loss, or background noise, perform your standard troubleshooting routine (GC inlet and column maintenance, leak test, Gain Factor Update, Bakeout, GF update, Autotune). (See “[Troubleshooting](#)” on page 41.)
- 4 If the troubleshooting did not improve the results, it may be time to apply the Clean Only mode to the source or perform manual cleaning.

The hydrogen flow can be incremented until adverse effects such as degraded spectra, peak tailing, compromised detection limits, etc., affect the analysis. Even a low flow setting, near the lowest values allowed (0.15, 0.21, 0.28 mL/min) should be found to be effective at extending the time between manual cleaning without substantial analytical degradation.

## Create and Run a JetClean Acquire & Clean Method

To create and run a GC/MS JetClean Acquire & Clean method, your MSD must be equipped with, and configured for a JetClean or CI flow gas controller, and Hydrogen gas must be connected to port B.

- 1 Set the MS Method Acquisition parameters.

- a Click **Method**  then open , and navigate to the data acquisition method you will use.
- b Save the acquisition method as a new file  (AcquireAndClean, for this example.)
- c Click **JetClean**, then, from the **Operation** drop-down, select **Acq & Clean**. This option will not be available if your MSD is not configured with a gas flow controller. (See [Figure 17](#).)
- d Note the hydrogen flow that displays is the default flow of 0.13. The hydrogen flow shown here must match the hydrogen flow you enter in the tune parameters (described below in [step 2](#)).

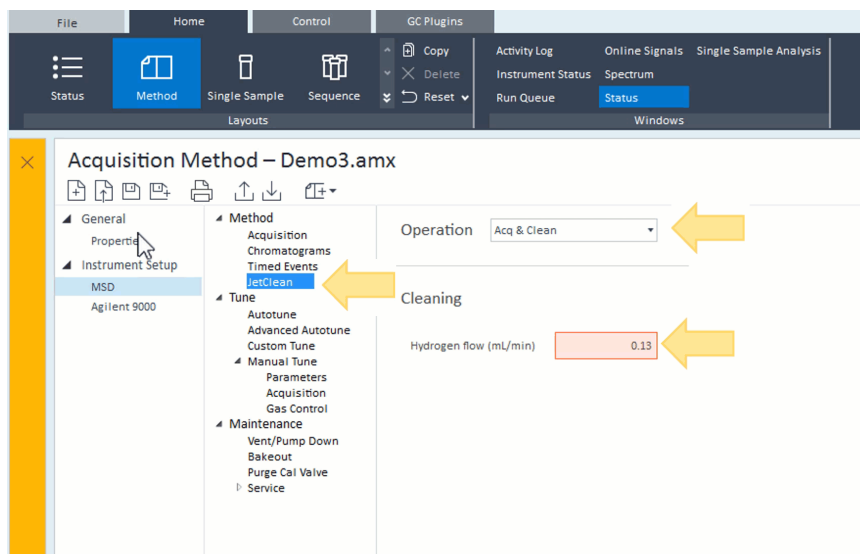
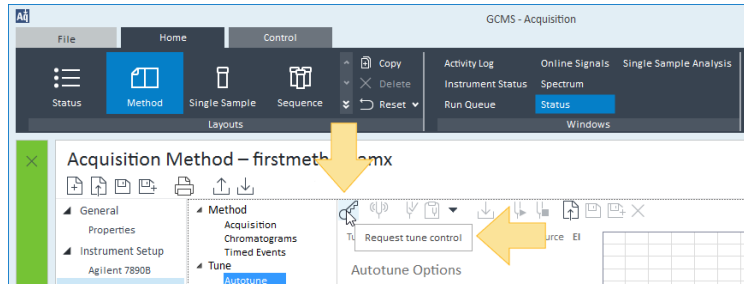

**Figure 17** Method Acquisition parameters

- e Save the acquisition method.

2 Set the tune parameters and tune the instrument.

- a Select **Tune > Autotune**, then click **Request tune control** . The Tune File associated with the currently loaded Method is loaded and the name and type are displayed. (See Figure 18.)

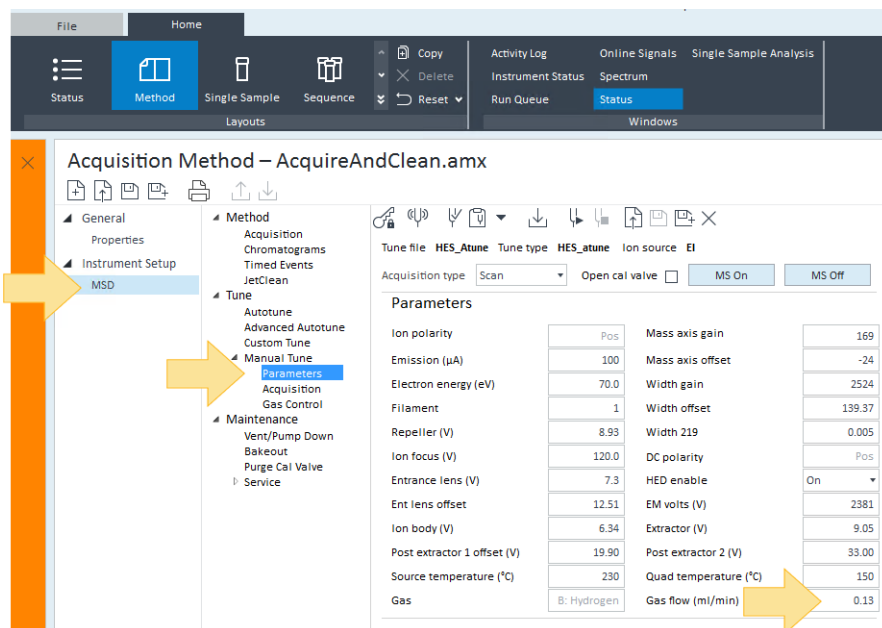

**Figure 18** Autotune selection



- a Select **Tune > Manual Tune > Parameters** and set the hydrogen **Gas flow** parameter to **0.13**. When developing your **Acquire and Clean** method, it is important to obtain the lowest possible hydrogen flow, while still observing good results. (See Figure 19 on page 38.)
- Too little hydrogen will fail to clean the source sufficiently.
  - Too much hydrogen will “over condition” the source.

### 3 Acquire & Clean Mode

The default parameter is a hydrogen flow of 0.13. To begin, use this default parameter for your JetClean method. Remember, the hydrogen flow set here must match the flow in your MS method parameters, described above in [step 1 on page 36](#) (0.13 is the default).



**Figure 19** Manual Tune parameters

- b** Save the tune file with a name that is recognizable as your Acquire and Clean tune file (e.g., AcquireandCleanHES\_Atune for this example).
- c** Click **Autotune the instrument** .
- d** After the autotune procedure runs, **release tune control** .

- 3 Load the newly created tune file into the MSD Acquisition parameters.
- a Select **MSD > Method > Acquisition**, click **Load a Tune File**  and select the tune file you created for this process. (**AcquireandCleanHES\_Atune** for this example.) (See [Figure 20](#) and [Figure 21](#).)

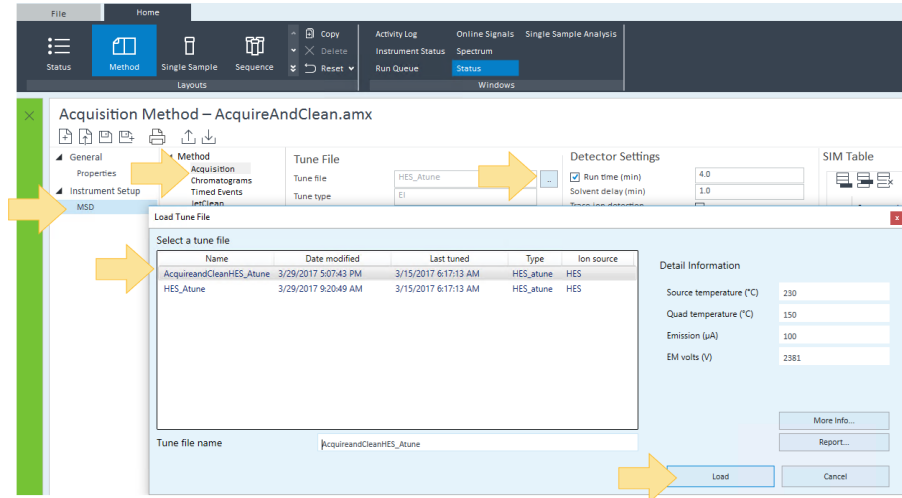

**Figure 20** Select a Tune file to Load

- b Save  the method. Both the GC and MS parameters, along with the method description, are saved with the method.

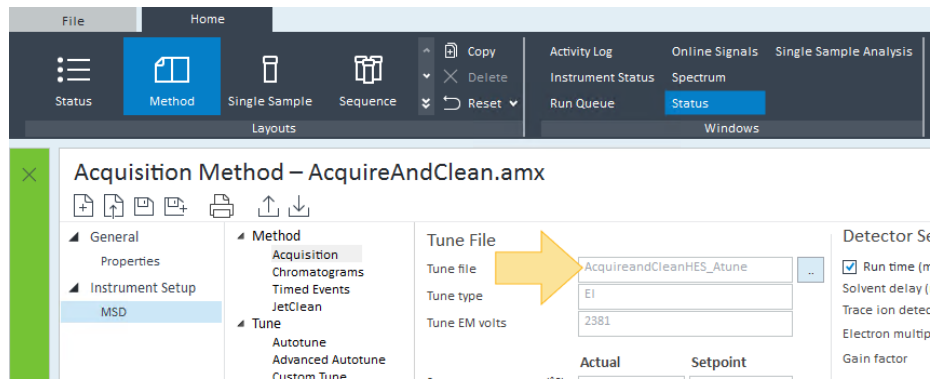
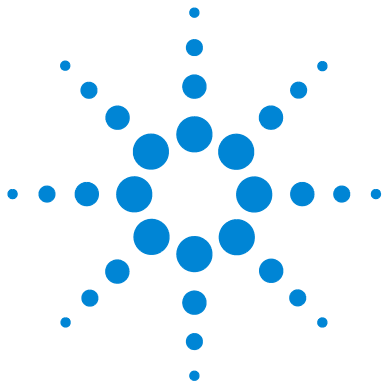

**Figure 21** Loaded Tune file

Now that the new tune file is loaded and the method is saved, you may process your samples as usual using this **Acquire and Clean** method.

### **3 Acquire & Clean Mode**





## 4 Troubleshooting

General Troubleshooting	42
Troubleshooting JetClean	43

### General Troubleshooting

When monitoring of the system background noise and signal strength or consistency indicates a need for troubleshooting, run these troubleshooting routines in the order shown here. After each step, run a sample to see if the problem is fixed.

- 1 Perform GC inlet and column maintenance.
- 2 Perform a leak test and correct any leaks. Always perform an air and water leak test before running any hydrogen through your system. In the presence of a leak, hydrogen can cause extreme damage.
- 3 Update the gain factor.
- 4 Bake the system and then check the gain factor again.
- 5 Retune and recalibrate the instrument.

**If all of the above steps fail to resolve the problems**, manually clean the ion source. Refer to your system's Operating Manual for details on how to manually clean the ion source.

If your system results are now satisfactory, and you are running in the JetClean **Clean Only** mode, run the JetClean **Clean Only** method, then resume your normal sample processing.

## Troubleshooting JetClean

When setting up JetClean, make sure that all lines are well purged.

When invoking JetClean in either mode (**Clean Only** or **Acquire & Clean**), observe the ion gauge setting when the flow is on.

A scan acquisition at a low gain factor can also be acquired to make sure that the hydrogen is entering the ion source.

Unique ions will indicate the presence of the hydrogen beyond the  $H_2^+$  itself:  $m/z$  3 ( $H_3^+$ ), 5 ( $HeH^+$ ), 19 ( $H_3O^+$ ) 29 ( $N_2H^+$ ), etc. The intense presence of the  $m/z$  29 ion is a good indicator of the hydrogen being present inside the source.

## **4 Troubleshooting**

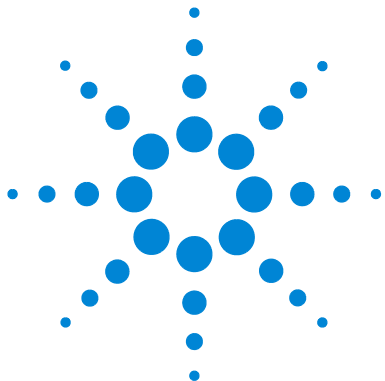

## 5 Hardware

Intended Use	46
Supported Systems	46
System Operation and Maintenance	47
Equipment Precautions	49
Operating Precautions	50
Hydrogen Plumbing	51
Changing the Hydrogen Supply Filter	54
Manually Cleaning the Ion Source	55
General Laboratory Precautions	55



### Intended Use

Agilent products must only be used in the manner described in the Agilent product user guides. Any other use may result in damage to the product or personal injury. Agilent is not responsible for any damages caused, in whole or in part, by improper use of the products, unauthorized alterations, adjustments or modifications to the products, failure to comply with procedures in Agilent product user guides, or use of the products in violation of applicable laws, rules or regulations.

### Supported Systems

The JetClean system accessory may be field installed by an Agilent Field Engineer or Service Representative. Agilent 7890 and 9000 GCs with the following MS configurations are supported:

- An Agilent 5975 series or 5977 series MSD with a high performance turbo pump.

Currently only the 7890 GC and the 9000 GC support JetClean and CI operating in EI mode.

## System Operation and Maintenance

### General warnings

**WARNING**

Before running an operation that requires the opening of the hydrogen supply shutoff valve to the JetClean system, all tubing, fittings, vacuum pump discharging plumbing, and controls must be thoroughly leak tested with an electronic hydrogen leak tester.

---

**WARNING**

Always check for leaks with an electronic hydrogen leak tester after changing a tank or servicing the gas lines. Never use soap to test a system using hydrogen for leaks.

---

**WARNING**

All compressed gas cylinders should be securely fastened to an immovable structure or permanent wall. Compressed gases should be stored and handled in accordance with the relevant safety codes. Gas cylinders should not be located in the path of heated oven exhaust.

---

**WARNING**

To avoid possible eye injury, wear eye protection when using compressed gas.

---

## Hydrogen supply plumbing

Figure 22 illustrates the plumbing for the hydrogen filter used with JetClean.

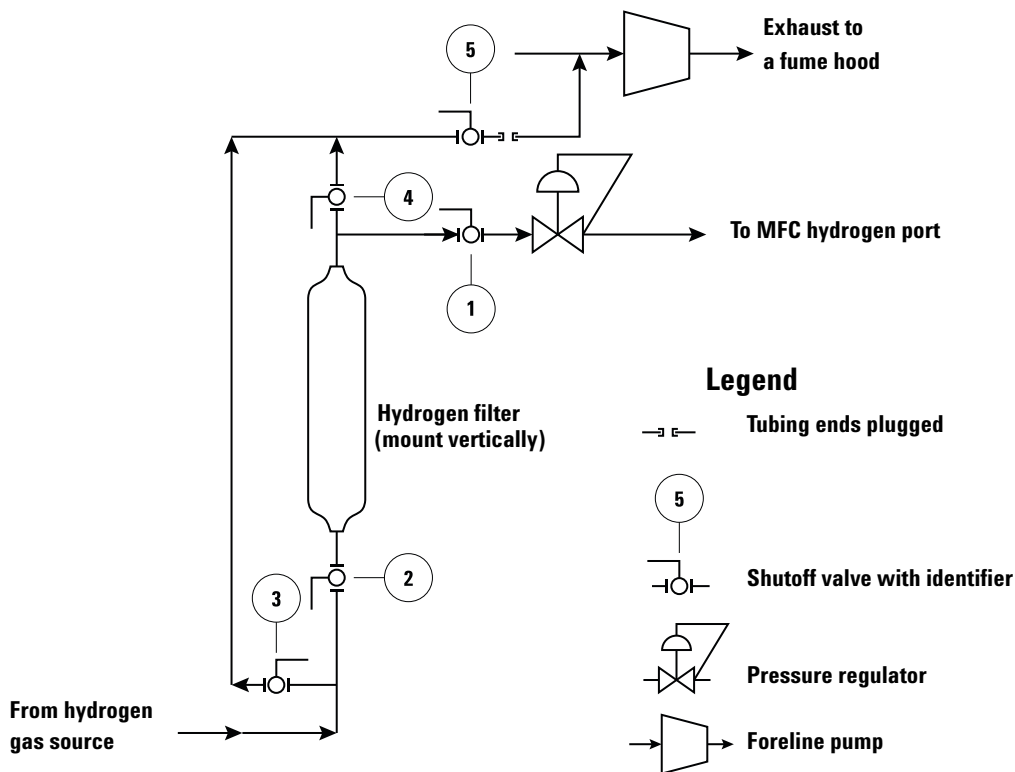

Figure 22 Filtered hydrogen supply to the MS

- 1 Connect the H<sub>2</sub> gas to the hydrogen port of the CI/JetClean MFC.
- 2 Configure the MS gases.
- 3 Tune the appropriate tune file.
- 4 Set the **Injection Source** to **valve\immediate start**. The inlet should not be set as **GC**.



## Equipment Precautions

Take the following precautions when operating a GC/MS system with the JetClean option that supplies hydrogen to the MS from a flow controller located on the analyzer.

### **WARNING**

**You MUST make sure the top thumbscrew on the analyzer side plate(s) are fastened finger-tight. Do not over tighten the thumbscrews; this can cause air leaks.**

**You MUST remove the plastic cover over the glass window on the front of the analyzer. In the unlikely event of an explosion, this cover may dislodge.**

---

Failure to follow the warning steps listed above greatly increases the chance of personal injury in the event of an explosion.

## Operating Precautions

When using hydrogen gas, check the system for leaks to prevent possible fire and explosion hazards based on local Environmental Health and Safety (EHS) requirements. Always check for leaks after changing a tank or servicing the gas lines. Always make sure the vent lines from the foreline pump or purge lines are vented into a fume hood.

- Turn off the hydrogen at its source every time you shut down the GC or MS.
- Do not use hydrogen as a collision cell gas.
- Turn off the hydrogen at its source every time you vent the MS.
- Turn off the hydrogen at its source every time shutoff valves in the MS are closed.
- Turn off the hydrogen at its source if a power failure occurs.
- If a power failure occurs while the GC/MS system is unattended, even if the system has restarted by itself:
  - a** Immediately turn off the hydrogen at its source.
  - b** Turn off the GC.
  - c** Turn off the MS and allow it to cool for 1 hour.
  - d** Eliminate all potential sources of ignition in the room.
  - e** Open the vacuum manifold of the MS to atmosphere.
  - f** Wait at least 10 minutes to allow any hydrogen to dissipate.
  - g** Start up the GC and MS as normal.

In addition to the information provided in this document, you should read and understand the warnings in the Hydrogen Safety Manual supplied with your system, and the Hydrogen Safety section of your operating manual.

## Hydrogen Plumbing

**WARNING**

**All compressed gas cylinders should be securely fastened to an immovable structure or permanent wall. Compressed gases should be stored and handled in accordance with the relevant safety codes.**

**Gas cylinders should not be located in the path of heated oven exhaust.**

**To avoid possible eye injury, wear eye protection when using compressed gas.**

---

### General recommendations

- You must supply pre-cleaned, 1/8-inch stainless steel (SS) tubing and a variety of 1/8-inch SS Swagelok fittings to connect the JetClean system to the hydrogen gas supply source.
- Agilent strongly recommends two-stage regulators to eliminate pressure surges. High-quality, low flow, stainless steel diaphragm-type regulators are especially recommended.
- On/off valves mounted on the outlet fitting of the two-stage regulator are not essential but are very useful. Be sure the valves have stainless-steel, packless diaphragms.
- Agilent strongly recommends installation of shut-off valves at each MS inlet supply fitting to allow the MS to be isolated for maintenance and troubleshooting.
- Flow and pressure controlling devices require at least 10 psi (138 kPa) pressure differential across them to operate properly.
- Set the gas pressure regulator to deliver 20 to 25 psig to the MFC connector.
- Situate auxiliary pressure regulators close to the MS inlet fittings. This ensures that the supply pressure is measured at the instrument (rather than at the source); pressure at the source may be different if the gas supply lines are long or narrow.
- Never use liquid thread sealer to connect fittings.
- Never use chlorinated solvents to clean tubing or fittings.

See Installation Kits for more information.

## Supply tubing for hydrogen gas

- Agilent recommends using new chromatographic quality stainless steel tubing and fittings when using hydrogen.
- Do not reuse old tubing when installing or switching to hydrogen gas. Hydrogen gas tends to remove contaminants left on old tubing by previous gases (by helium, for example). These contaminants can appear in output as high background noise or hydrocarbon contamination for several weeks.
- Especially do not use old copper tubing, which can become brittle.

## Hydrogen supply systems

To eliminate pressure surges, use a two-stage pressure regulator with each hydrogen gas cylinder. Stainless steel, diaphragm type regulators are recommended. The pressure flow to the back of the JetClean or CI flow module is approximately 25 psi. (See [Figure 23](#).)

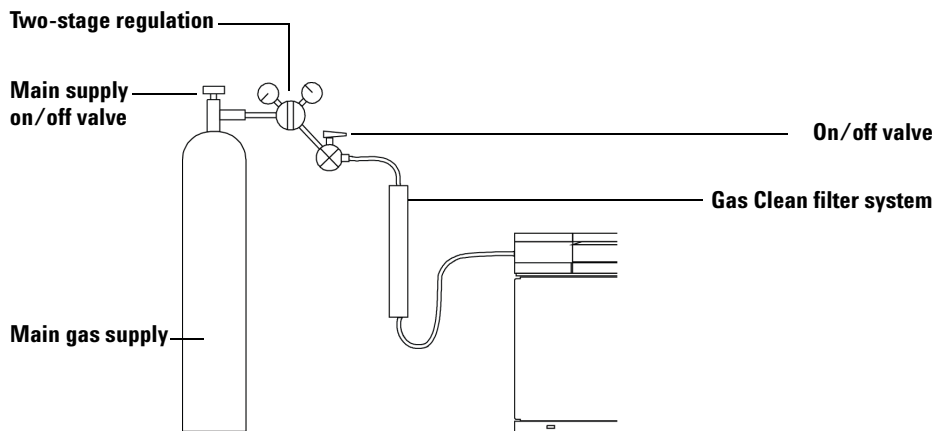

**Gas Clean filter configuration will vary depending on the application.**

**Figure 23** Hydrogen gas cylinder supply tubing

The type of regulator you use depends on the gas type and supplier. The Agilent catalog for consumables and supplies contains information to help you identify the correct regulator, as determined by the Compressed Gas Association (CGA). Agilent Technologies offers pressure-regulator kits that contain all the materials needed to install regulators properly.

## Pressure regulator gas supply tubing connections

Use PTFE tape to seal the pipe-thread connection between the pressure regulator outlet and the fitting to which you connect the gas tubing.

Instrument grade PTFE tape (part number 0460-1266), from which volatiles have been removed, is recommended for all fittings. Do not use pipe dope to seal the threads; it contains volatile materials that will contaminate the tubing.

## Changing the Hydrogen Supply Filter

Periodically change the filter on the hydrogen supply to the JetClean system. If the system is pressurized with hydrogen you must evacuate hydrogen from the filter before removing the filter.

- 1 Close the hydrogen supply manual shutoff valve ① labeled hydrogen, to the mass flow controller (MFC). (See [Figure 22](#) on page 48.)
- 2 Close the manual shutoff valve ② on the hydrogen supply filter inlet.
- 3 In your Acquisition software program, from **Method > MSD > Tune > Gas Control**, fully open the hydrogen valve.
- 4 Vent the MS.
- 5 Verify the filter bypass line exit shutoff valve ⑤ is closed and remove the threaded plug from this valve.
- 6 Remove the plug on the tubing line to the foreline pump inlet so it can attach to the filter bypass line in the next step.
- 7 Attach the filter bypass line exit valve ⑤ to the tubing line attached to the foreline pump inlet.
- 8 If the MS is off, turn it on and wait until the turbo pump starts. The JetClean system is now under vacuum.
- 9 In your Acquisition software program, from **Method > MSD > Tune > Gas Control**, fully open the hydrogen valve so that the pressure regulator and MFC both open fully.
- 10 Open the shutoff valve ⑥ on the filter outlet line going to the foreline pump inlet. This evacuates hydrogen from the filter through the foreline pump to a lab hood exhaust.
- 11 After 10 minutes, close the shutoff valve ⑥ on the filter outlet line going to the foreline pump inlet.
- 12 Remove the old filter and replace it with a new one.
- 13 With the vent line valve ⑤ closed, remove the tubing from this valve that is going to the foreline pump and plug the end of this tubing and also plug this valve. This prevents someone from mistakenly opening this valve and allowing hydrogen to flow directly into the laboratory.
- 14 Ensure that the vent shutoff valves on the filter inlet ③ and filter outlet ④ are closed.

- 15 In your Acquisition software program, from **Method > MSD > Tune > Gas Control**, close the hydrogen valve.
- 16 With the vacuum pump still running, open the hydrogen shutoff valves on the filter inlet ② and filter outlet ① and use an electronic hydrogen leak tester to test the system for leaks.

## Manually Cleaning the Ion Source

See your system's Operating Manual for details on how to manually clean the ion source.

## General Laboratory Precautions

The use of hydrogen as a GC carrier gas, or as a reagent gas for the JetClean system, is potentially dangerous. Hydrogen presents a number of dangers. Some are general, others are unique to GC or GC/MS operation.

Be sure to read the following information and the section on Hydrogen Safety in your instruments Operating manual before operating the JetClean system.

- 1 Clearly identify the JetClean system hydrogen tubing runs with local code required hydrogen labels.
- 2 Use leak-checking equipment to periodically monitor for leaks in the JetClean system. This includes the hydrogen supply source system (tank or generator), hydrogen supply lines to the JetClean gas inlet on the MS, the mass flow controller (MFC) system plumbing, the reagent system plumbing including the CI calibration valve/vial, and transfer line to the analyzer chamber. Agilent highly recommends the G3388B Leak Detector to safely check for hydrogen leaks.
- 3 Eliminate from your laboratory as many ignition sources as possible (for example, open flames, devices that can spark and sources of static electricity).
- 4 Do not allow hydrogen from a high pressure cylinder to vent directly to atmosphere due to danger of self-ignition.
- 5 If you have a pin hole in your line, you can have a flame, and hydrogen flames are invisible. Additionally, the lower explosive limit for hydrogen is 4%.
- 6 Include hydrogen sensors in your laboratory in the locations as recommended by the sensor manufacture.



**Agilent Technologies**

© Agilent Technologies, Inc.

Printed in USA, September 2017



G7077-90118